

# PCAN-MicroMod Analog 1

Application-specific PCAN-MicroMod  
Motherboard

## User Manual

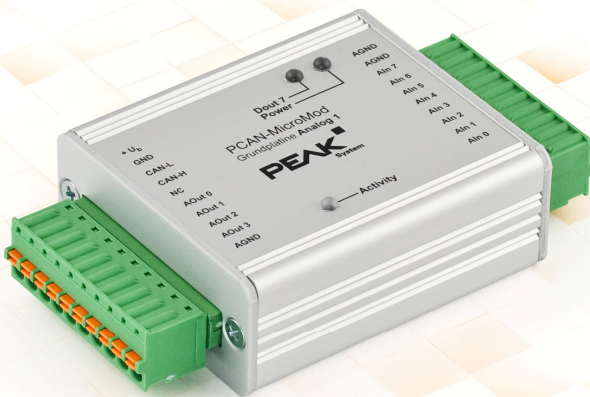

Document version 1.11.1 (2014-03-11)

**PEAK**  
System

## Products taken into account

Product Name	Model	Part number
PCAN-MicroMod Analog 1	Including casing and PCAN-MicroMod	IPEH-002204
PCAN-MicroMod Configuration	Version 2.5 (Windows software)	

CANopen® and CiA® are registered community trade marks of CAN in Automation e.V.

All other product names mentioned in this document may be the trademarks or registered trademarks of their respective companies. They are not explicitly marked by "™" and "®".

© 2014 PEAK-System Technik GmbH

PEAK-System Technik GmbH  
Otto-Roehm-Strasse 69  
64293 Darmstadt  
Germany

Phone: +49 (0)6151 8173-20  
Fax: +49 (0)6151 8173-29

[www.peak-system.com](http://www.peak-system.com)  
[info@peak-system.com](mailto:info@peak-system.com)

Document version 1.11.1 (2014-03-11)

# Contents

<b>1</b>	<b>Introduction</b>	<b>4</b>
1.1	Properties at a Glance	4
1.2	Prerequisites for Operation	5
1.3	Scope of Supply	6
<b>2</b>	<b>Hardware Configuration</b>	<b>7</b>
2.1	Modification on Nominal Supply Voltages > 12 V	8
2.2	Measuring Range Extension of the Inputs	9
<b>3</b>	<b>Operation</b>	<b>10</b>
3.1	Port Assignment	10
3.2	Configuration Program	11
3.2.1	System Prerequisites	11
3.2.2	Installing the Program	12
3.2.3	Creating a Configuration	12
3.2.4	Applicable MicroMod Services	13
3.3	Status LEDs	14
3.4	Several MicroMods on the CAN Bus	14
<b>4</b>	<b>Technical Specifications</b>	<b>16</b>
	<b>Appendix A CE Certificate</b>	<b>18</b>
	<b>Appendix B Dimension Drawing</b>	<b>19</b>

# 1 Introduction

The motherboards for PCAN-MicroMod provide an application-oriented environment. Typical characteristics of this product group include a wide supply voltage range and the protective circuit for the inputs and outputs. CANopen® firmware is available for all PCAN-MicroMod motherboards.

The Analog 1 motherboard serves common analog requirements.



**Note:** This manual only refers to the motherboard as base for a PCAN-MicroMod and to the standard firmware. For the PCAN-MicroMod and the configuration program PCAN-MicroMod Configuration, there is separate documentation.

## 1.1 Properties at a Glance

- Completely configurable using the Windows program PCAN-MicroMod Configuration
- Communication through High-speed CAN (ISO 11898-2)
- Operating voltage 11 to 26 V (8 to 26 V w/o use of analog outputs)
- Aluminum profile casing with spring terminal connectors
- Top hat rail mounting option available
- Extended operating temperature range from -40 to +85 °C (-40 to +185 °F)

- └ 8 analog inputs:
  - Pull-down circuit
  - Measuring range unipolar 0 to 5 V
  - Resolution 10 bits
  - Sampling rate 1 kHz
  - Measuring range extension possible
  - Protection against undervoltage and overvoltage
  - Parallel connection of a digital input for each analog input (alternative use, e.g. for a push button)
- └ 4 analog outputs:
  - Voltage range 0 to 10 V (based on 8-bit PWM)
  - Load ability: 15 mA, short-circuit proof
- └ Status LEDs for power supply and digital output

## 1.2 Prerequisites for Operation

- └ Power supply in the range of 11 to 26 V DC (8 to 26 V w/o use of analog outputs)
- └ For creating and transferring configurations: computer with Windows 8, 7, Vista, XP (32-bit or 64-bit) and a CAN interface from the PCAN series

## 1.3 Scope of Supply

- └ PCAN-MicroMod
- └ PCAN-MicroMod motherboard in casing including mating connectors
- └ PCAN-MicroMod Configuration for Windows
- └ Manual in PDF format

## 2 Hardware Configuration

You can customize the motherboard by modifying the hardware. The following subsections contain descriptions about possible modifications.

### Accessing the Motherboard

In order to carry out the modifications described in the following sections, unscrew the lid of the casing and pull off the MicroMod from the motherboard.



**Attention!** Electrostatic discharge (ESD) can damage or destroy components on the motherboard or the PCAN-MicroMod. Take precautions to avoid ESD when handling the boards.

### Remounting the MicroMod

When you remount the MicroMod, take notice of the white triangular marks on each the motherboard and the MicroMod (upper left corner). These marks must align.

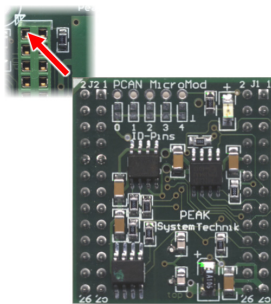

Figure 1: Positioning of the MicroMod

## 2.1 Modification on Nominal Supply Voltages > 12 V

If you want to supply the Analog 1 motherboard with a nominal voltage  $+U_b > 12\text{ V}$  (usually 24 V), then you must do the following modification:

1. Equip the unpopulated position D6 with a reference diode BZV55C12 (package SOD-80).
2. Replace the 0-Ohm resistor on position R35 with a resistor of 1.6 k $\Omega$  (package S1206).

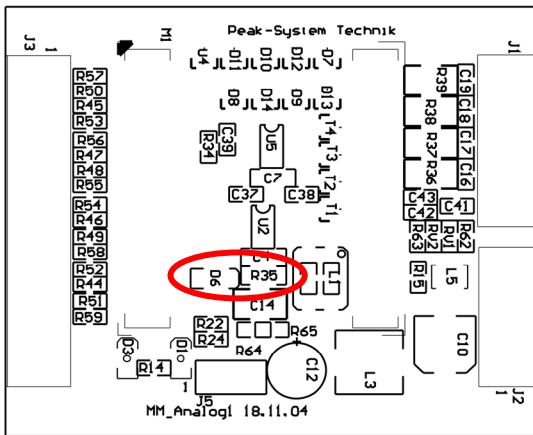

Figure 2: Positions D6 and R35



**Note:** You do not need to consider voltage fluctuations that might occur. A modification isn't required in that case. Example: In the automotive sector up to 18 V may occur at a nominal voltage of 12 V.



## 2.2 Measuring Range Extension of the Inputs

You can extend the measuring range of each analog input to a higher maximum voltage than 5 Volts by using a voltage divider. On delivery of the motherboard the resistor positions R52 through R59 are not equipped. By inserting a resistor  $R_x$  (package S0805) with a value calculated with the following formula the measuring range is extended to the desired maximum voltage  $U_{MB}$ .

$$R_x = \frac{2400 \Omega}{\frac{U_{MB}}{5V} - 1} \quad (U_{MB} > 5V)$$

Analog input	Insert $R_x$ on position
Aln 0	R57
Aln 1	R53
Aln 2	R56
Aln 3	R55
Aln 4	R54
Aln 5	R58
Aln 6	R52
Aln 7	R59

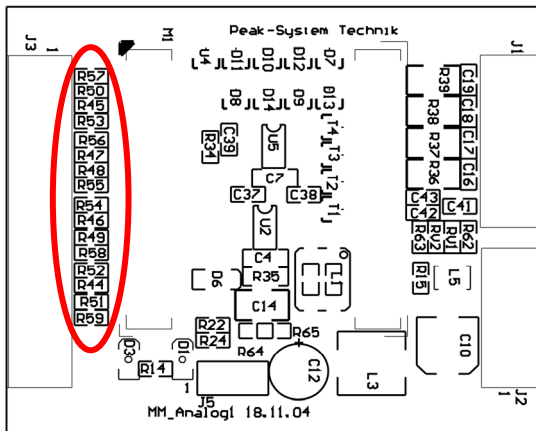

Figure 3: Position of the resistors for the measuring range extension

## 3 operation

### 3.1 Port Assignment

The motherboard has two connectors, J1/2 on the left and J3 on the right. The port assignment is as follows:

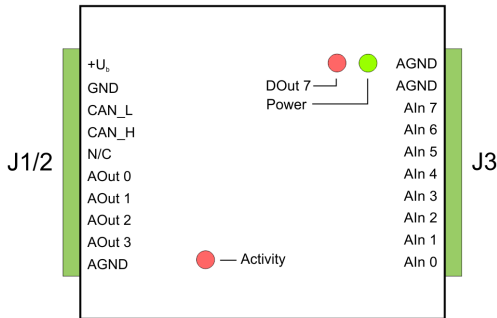

Figure 4: Ports of the Analog 1 motherboard

Port name J1/2	Function
+U <sub>b</sub>	Operating voltage 11 - 26 V DC, w/o AOut 8 - 26 V DC See also section 2.1 <i>Modification on Nominal Supply Voltages &gt; 12 V</i> on page 8.
GND	Digital ground
CAN_L	Differential CAN signal
CAN_H	
N/C	Not connected
AOut 0	Analog output 0 - 10 V
AOut 1	
AOut 2	
AOut 3	
AGND	Analog ground

Port name J3	Function
AGND	Analog ground
AGND	
AIn 7	Analog input, digital input parallel (e.g. for a button)
AIn 6	
AIn 5	
AIn 4	
AIn 3	
AIn 2	
AIn 1	
AIn 0	

## 3.2 Configuration Program

In order to create and transfer MicroMod configurations, the Windows program PCAN-MicroMod Configuration is used. This section covers basic points about installation and use of the program with the Analog 1 motherboard.

You'll find detailed information about the use of PCAN-MicroMod Configuration in the related documentation which is invoked via the program (e.g. with **F1**).

### 3.2.1 System Prerequisites

- Windows 8, 7, Vista, XP (32-bit or 64-bit)
- Computer with CAN interface of the PCAN series (for transferring a configuration to the PCAN-MicroMod via CAN)

### 3.2.2 Installing the Program

Under Windows install the program from the supplied DVD. Start the corresponding installation routine by using the DVD navigation going to **Tools > PCAN-MicroMod Configuration 2.5.x**.

### 3.2.3 Creating a Configuration

When you start creating a new configuration in PCAN-MicroMod Configuration, the **Board Type** dialog box appears in order to select the type of the used motherboard. The necessary settings are explained in the following.

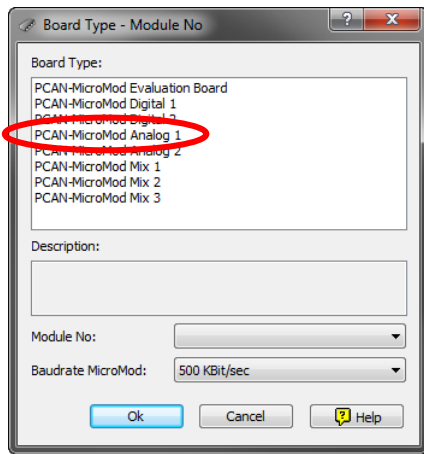

Figure 5: PCAN-MicroMod Configuration: selection of the Analog 1 motherboard

**Board Type:** PCAN-MicroMod Analog 1

**Module No:** 0

The module number of the MicroMod on the Analog 1 motherboard is set to 0 at delivery and is relevant if you want to configure more than one MicroMod on the same CAN bus. See also section 3.4 *Several MicroMods on the CAN Bus* on page 14.

### Bitrate MicroMod: 500 kbit/s







At delivery the MicroMod is set to a bit rate of 500 kbit/s. A change of this setting will take effect after sending the completed configuration to the MicroMod.



**Note:** For the first transfer of a configuration to the module it must be integrated in a CAN network with a bit rate of 500 kbit/s.

### 3.2.4 Applicable MicroMod Services

The motherboard's inputs and outputs are controlled by the services of the MicroMod. The following table shows the assignment of the motherboard functions to the MicroMod services.

Function on motherboard	Port name	Access with MicroMod service(s)
Analog input	Aln 0 ... Aln 7	 Analog Input  Curve  Analog Hysteresis
Digital input (parallel to the channels Aln 0 ... Aln 7)		 Digital Function  Rotary Encoder
Analog output (PWM with 4000 Hz)	AOut 0 ... AOut 3	 PWM and Frequency Output
LED DOut 7	DOut 7	 Digital Output

### 3.3 Status LEDs

The motherboard including the MicroMod has three LEDs with the following status indications:

LED	Indication
Power (green)	Power is applied.
DOut 7 (red)	Is linked to the digital output DO 7 of the MicroMod and can be configured freely.
Activity (red)	Status of the PCAN-MicroMod:
blinking at 1 Hz	normal operation
blinking at 2 Hz	invalid or no configuration
blinking at 5 Hz	configuration mode
continuously on	internal MicroMod error

### 3.4 Several MicroMods on the CAN Bus

If you want to use several MicroMods on the same CAN bus and want to configure them, each one needs its own module number. That way the MicroMods are distinguishable for the program PCAN-MicroMod Configuration.

The module number is set on the MicroMod by solder jumpers and lies in the range of 0 to 31. At **delivery** each MicroMod has the **module number 0**.

During normal operation of the PCAN-MicroMod, the module number has no effect on the CAN communication.

For setting the solder jumpers on the MicroMod unscrew the top of the casing and remove the MicroMod from the motherboard. Please find further information about the assignment of module numbers in the separate user manual for the PCAN-MicroMod.



**Attention!** Electrostatic discharge (ESD) can damage or destroy components on the motherboard or the PCAN-MicroMod. Take precautions to avoid ESD when handling the boards.

## Remounting the MicroMod

When you remount the MicroMod, take notice of the white triangular marks on each the motherboard and the MicroMod (upper left corner). These marks must align.

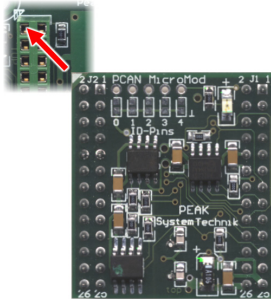

Figure 6: Positioning of the MicroMod

## 4 Technical specifications

### Power supply

Operating voltage +U <sub>b</sub>	11 - 26 V DC ( $\pm 5\%$ ), 8 - 26 V w/o AOut
Current consumption	max. 200 mA, typ. 35 mA at 12 V w/o Last
Ripple (5 V)	< 50 mV (+U <sub>b</sub> = 12 V, 200 mA load)
Ripple (analog)	< 20 mV
Reverse-polarity protection	extant; can get ineffective by the wiring with other CAN nodes (danger of destruction of electronic components)

### Analog inputs

Count	8
Measuring range	0 - 5 V, optionally extendable
Resolution	10 bits
Sampling rate	1 kHz
Input impedance	< 5 k $\Omega$
Overvoltage protection	extant
Low-pass	f <sub>g</sub> = 66 Hz
Special feature	Digital inputs of PCAN-MicroMod parallel (digital assessment w/o threshold switch possible)

### Analog outputs

Count	4
Type	PWM based
Voltage range	0 - 10 V
Resolution	full percentage steps (0 to 100 %)
Output current	15 mA
Short circuit protection	extant



### CAN

Transmission standard	High-speed CAN ISO 11898-2, typ. 500 kbit/s, setup with PCAN-MicroMod Configuration (Windows software)
Termination	none
CAN ID reserved for configuration transfer	0x7E7
Module number at delivery (for configuration transfer)	0

### Peculiarity Interference Immunity

Tests	compliant to IEC 61000 and DIN EN 61326
Surge	$\pm 500$ V (specification industrial sector: $\pm 1$ kV) <sup>1</sup>
Line-conducted HF compatibility	10 V <sub>eff</sub> (specification: 3 V <sub>eff</sub> )

### Environment

Operating temperature	-40 - +85 °C (-40 - +185 °F)
Temperature for storage and transport	-40 - +100 °C (-40 - +212 °F)
Relative humidity	15 - 90 %, not condensing
Ingress protection (IEC 60529)	IP20
EMC	DIN EN 61326-1:2013-07 EC directive 2004/108/EG

### Measures

Casing size (incl. connectors)	55 x 68 x 24 mm See also dimension drawing in Appendix B on page 19
Weight	108 g

<sup>1</sup> This specification could only be fulfilled with  $\pm 500$  V due to the available space. Therefore the motherboard should be used with a local power supply.

# Appendix A CE Certificate

PCAN-MicroMod Analog 1 IPEH-002204 – EC Declaration of Conformity  
PEAK-System Technik GmbH



## Notes on the CE Symbol

The following applies to the "PCAN-MicroMod Analog 1" product with the item number(s) IPEH-002204.

**EC Directive** This product fulfills the requirements of EU EMC Directive 2004/108/EC (Electromagnetic Compatibility) and is designed for the following fields of application as for the CE marking:

**Electromagnetic Immunity/Emission**  
DIN EN 61326-1, publication date 2013-07  
Electrical equipment for measurement, control and laboratory use – EMC requirements – Part 1: General requirements (IEC 61326-1:2012);  
German version EN 61326-1:2013

**Declarations of Conformity** In accordance with the above mentioned EU directives, the EC declarations of conformity and the associated documentation are held at the disposal of the competent authorities at the address below:

**PEAK-System Technik GmbH**

Mr. Wilhelm  
Otto-Roehm-Strasse 69  
64293 Darmstadt  
Germany

Phone: +49 (0)6151 8173-20  
Fax: +49 (0)6151 8173-29  
E-mail: info@peak-system.com

A handwritten signature in black ink, appearing to read "Uwe W. H.", written in a cursive style.

Signed this 22<sup>nd</sup> day of October 2013

# Appendix B Dimension Drawing

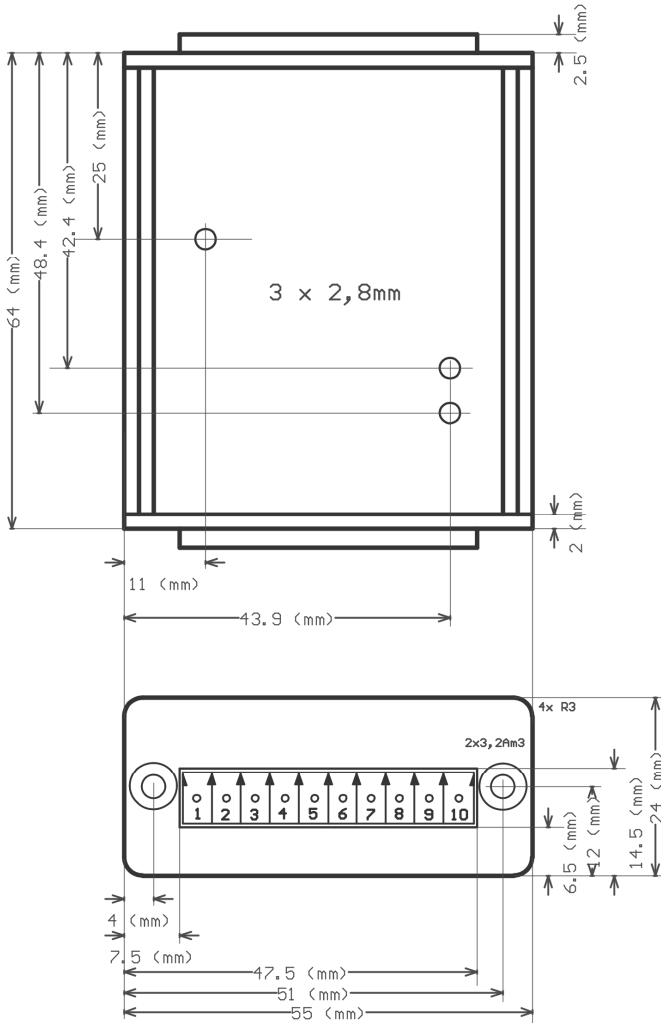

Figure 7: Top view and view of front side with connector. The figure does not show the actual size of the product.