

PCAN-MicroMod Mix 1

Application-specific PCAN-MicroMod
Motherboard

User Manual



Products taken into account

Product Name	Model	Part number
PCAN-MicroMod Mix 1	Including casing and PCAN-MicroMod	IPEH-002202
PCAN-MicroMod Configuration	Version 2.5 (Windows software)	

CANopen® and CiA® are registered community trade marks of CAN in Automation e.V.

All other product names mentioned in this document may be the trademarks or registered trademarks of their respective companies. They are not explicitly marked by "™" and "®".

© 2014 PEAK-System Technik GmbH

PEAK-System Technik GmbH
Otto-Roehm-Strasse 69
64293 Darmstadt
Germany

Phone: +49 (0)6151 8173-20
Fax: +49 (0)6151 8173-29

www.peak-system.com
info@peak-system.com

Document version 1.11.1 (2014-03-11)

Contents

1	Introduction	4
1.1	Properties at a Glance	4
1.2	Prerequisites for Operation	6
1.3	Scope of Supply	6
2	Hardware Configuration	7
2.1	Modification on Nominal Supply Voltages > 12 V	8
2.2	Pull-up/Pull-down Circuits for the Digital Inputs	9
2.3	Measuring Range Extension of the Analog Inputs	11
3	Operation	12
3.1	Port Assignment	12
3.2	Configuration Program	13
3.2.1	System Prerequisites	13
3.2.2	Installing the Program	14
3.2.3	Creating a Configuration	14
3.2.4	Applicable MicroMod Services	15
3.3	Status LEDs	16
3.4	Several MicroMods on the CAN Bus	16
4	Technical Specifications	18
	Appendix A CE Certificate	21
	Appendix B Dimension Drawing	22

1 Introduction

The motherboards for PCAN-MicroMod provide an application-oriented environment. Typical characteristics of this product group include a wide supply voltage range and the protective circuit for the inputs and outputs. CANopen® firmware is available for all PCAN-MicroMod motherboards.

The Mix 1 motherboard serves common analog and digital requirements and supports temperature measurement.

 **Note:** This manual only refers to the motherboard as base for a PCAN-MicroMod and to the standard firmware. For the PCAN-MicroMod and the configuration program PCAN-MicroMod Configuration, there is separate documentation.

1.1 Properties at a Glance

- Completely configurable using the Windows program PCAN-MicroMod Configuration
- Communication through High-speed CAN (ISO 11898-2)
- Operating voltage 8 to 26 V
- Aluminum profile casing with spring terminal connectors
- Top hat rail mounting option available
- Extended operating temperature range from -40 to +85 °C (-40 to +185 °F)

- └ 6 digital inputs:
 - Pull-up or pull-down circuit selectable (in 3 groups)
 - High state at 5 to 18 V input voltage
 - Schmitt trigger behavior, inverting
 - Low-pass behavior
 - Parallel connection of a frequency input (for each digital input 0 to 3) for alternative use (e.g. fast status changes, countings)
- └ 2 temperature inputs for connection of thermistors (type EC95F103W), measuring range 0 to 70 °C (32 to 158 °F)
- └ 2 analog inputs:
 - Pull-down circuit
 - Measuring range unipolar 0 to 5 V
 - Resolution 10 bits
 - Sampling rate 1 kHz
 - Measuring range extension possible
 - Protection against undervoltage and overvoltage
- └ 2 digital/frequency outputs:
 - Fast low-side switches, max. 55 V, 0.75 A
 - Maximum frequency 10 kHz
 - Short circuit protection
- └ Status LEDs for power supply and digital output

1.2 Prerequisites for Operation

- └ Power supply in the range of 8 to 26 V DC
- └ For creating and transferring configurations: computer with Windows 8, 7, Vista, XP (32-bit or 64-bit) and a CAN interface from the PCAN series

1.3 Scope of Supply

- └ PCAN-MicroMod
- └ PCAN-MicroMod motherboard in casing including mating connectors
- └ PCAN-MicroMod Configuration for Windows
- └ Manual in PDF format

2 Hardware Configuration

You can customize the motherboard by modifying the hardware. The following subsections contain descriptions about possible modifications.

Accessing the Motherboard

In order to carry out the modifications described in the following sections, unscrew the lid of the casing and pull off the MicroMod from the motherboard.



Attention! Electrostatic discharge (ESD) can damage or destroy components on the motherboard or the PCAN-MicroMod. Take precautions to avoid ESD when handling the boards.

Remounting the MicroMod

When you remount the MicroMod, take notice of the white triangular marks on each the motherboard and the MicroMod (upper left corner). These marks must align.

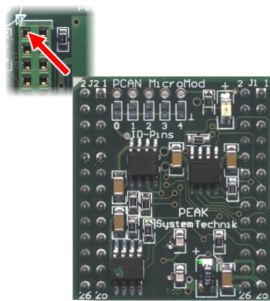

Figure 1: Positioning of the MicroMod

2.1 Modification on Nominal Supply Voltages > 12 V

If you want to supply the Mix 1 motherboard with a nominal voltage $+U_b > 12\text{ V}$ (usually 24 V), then you must do the following modification:

1. Equip the unpopulated position D6 with a reference diode BZV55C12 (package SOD-80).

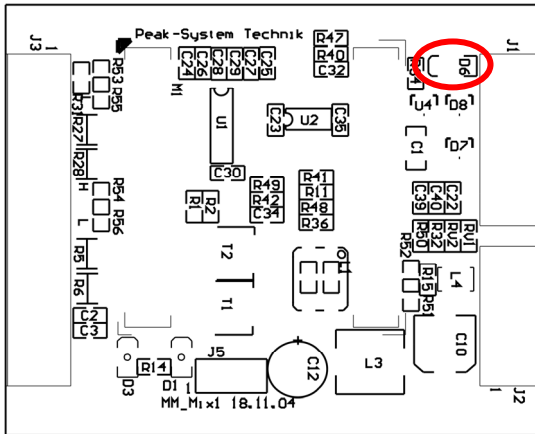

Figure 2: Position D6 (top side of the PCB)

2. Replace the 0-Ohm resistor on position R33 with a resistor of 1.6 k Ω (package S1206).

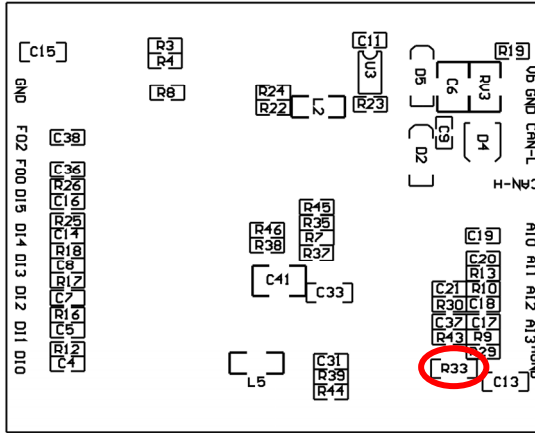

Figure 3: Position R33 (bottom side of the PCB)

Note: You do not need to consider voltage fluctuations that might occur. A modification isn't required in that case. Example: In the automotive sector up to 18 V may occur at a nominal voltage of 12 V.

2.2 Pull-up/Pull-down Circuits for the Digital Inputs

At delivery the digital inputs are set to pull-up circuits. You can set them to pull-down circuit in groups. This is done by repositioning resistors.

Digital inputs	Pull-up (+U _b) [*]	Pull-down (GND)
DIn 0	R31 (2.7 kΩ)	R12 (2.7 kΩ)
DIn 1 and DIn 2	R53 (0 Ω)	R55 (0 Ω)
DIn 3 to DIn 5	R54 (0 Ω)	R56 (0 Ω)

^{*} Setting at delivery

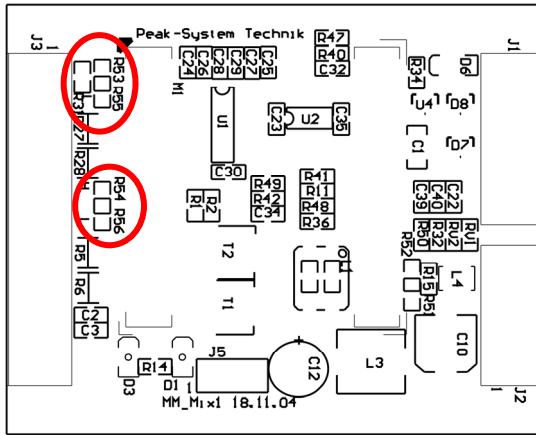

Figure 4: Positions R31, R53/R55, R54/R56 (top side of the PCB)

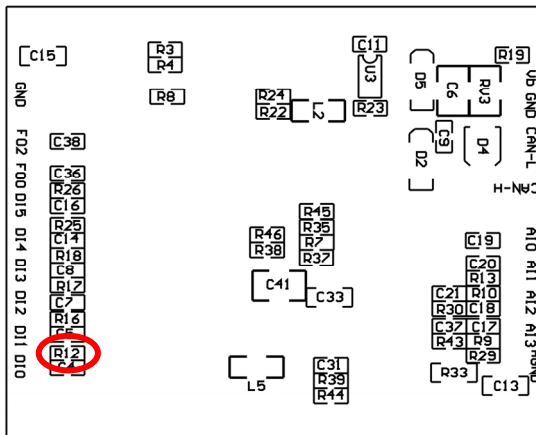

Figure 5: Position R12 (bottom side of the PCB)



Attention! Double-check for inadvertent short circuits after altering the setup, especially at positions R53/R55 and R54/R56.

2.3 Measuring Range Extension of the Analog Inputs

You can extend the measuring range of each analog input to a higher maximum voltage than 5 Volts by using a voltage divider. On delivery of the motherboard the resistor positions R30 and R43 on the bottom side of the PCB are not equipped. By inserting a resistor R_x (package S0805) with a value calculated with the following formula the measuring range is extended to the desired maximum voltage U_{MB} .

$$R_x = \frac{2400 \Omega}{\frac{U_{MB}}{5V} - 1} \quad (U_{MB} > 5V)$$

Analog input	Insert R_x on position
Aln 2	R30
Aln 3	R43

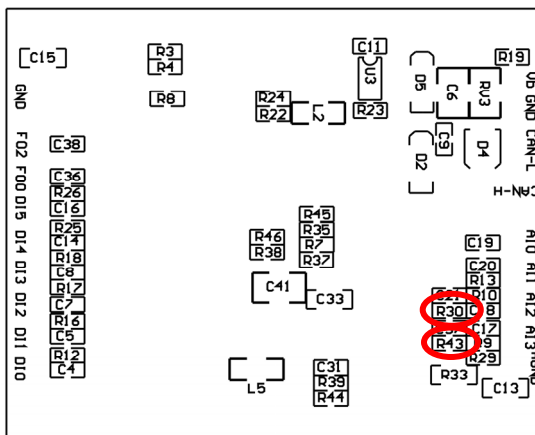

Figure 6: Positions R30 and R43 (bottom side of the PCB)

3 operation

3.1 Port Assignment

The motherboard has two connectors, J1/2 on the left and J3 on the right. The port assignment is as follows:

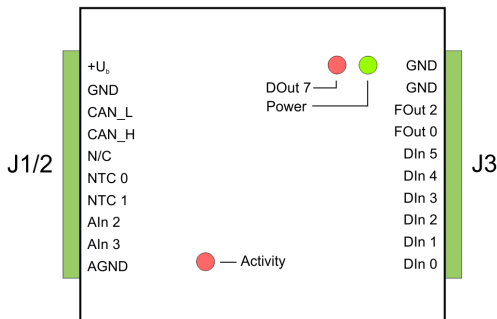

Figure 7: Ports of the Mix 1 motherboard

Port name J1/2	Function
+U _b	Operating voltage 8 - 26 V DC See also section 2.1 <i>Modification on Nominal Supply Voltages > 12 V</i> on page 8.
GND	Digital ground
CAN_L	Differential CAN signal
CAN_H	
N/C	Not connected
NTC 0	Connection thermistor (against AGND)
NTC 1	
AIn 2	Analog input
AIn 3	
AGND	Analog ground

Port name J3	Function
GND	Digital ground
GND	
FOut 2	Frequency output
FOut 0	
DIn 5	Digital input
DIn 4	
DIn 3	Digital input, frequency input parallel
DIn 2	
DIn 1	
DIn 0	

3.2 Configuration Program

In order to create and transfer MicroMod configurations the Windows software PCAN-MicroMod Configuration is used. This section covers basic points about installation and use of the program with the Mix 1 motherboard.

You'll find detailed information about the use of PCAN-MicroMod Configuration in the related documentation which is invoked via the program (e.g. with **F1**).

3.2.1 System Prerequisites

- Windows 8, 7, Vista, XP (32-bit or 64-bit)
- Computer with CAN interface of the PCAN series (for transferring a configuration to the PCAN-MicroMod via CAN)

3.2.2 Installing the Program

Under Windows install the program from the supplied CD. Start the corresponding installation routine by using the CD navigation going to **Tools > PCAN-MicroMod Configuration 2.5.x**.

3.2.3 Creating a Configuration

When you start creating a new configuration in PCAN-MicroMod Configuration, the **Board Type** dialog box appears in order to select the type of the used motherboard. The necessary settings are explained in the following.

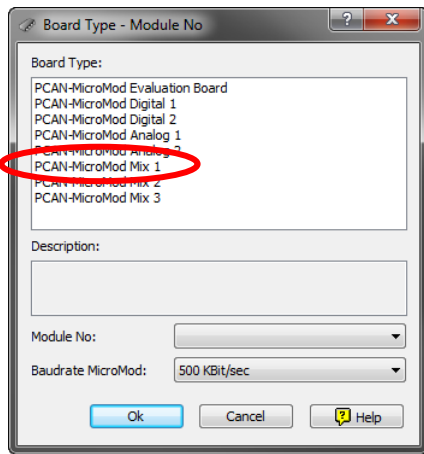

Figure 8: PCAN-MicroMod Configuration: selection of the Mix 1 motherboard

Board Type: PCAN-MicroMod Mix 1

Module No: 0

The module number of the MicroMod on the Mix 1 motherboard is set to 0 at delivery and is relevant if you want to configure more than one MicroMod on the same CAN bus. See also section 3.4 *Several MicroMods on the CAN Bus* on page 16.

Bitrate MicroMod: 500 kbit/s











At delivery the MicroMod is set to a bit rate of 500 kbit/s. A change of this setting will take effect after sending the completed configuration to the MicroMod.



Note: For the first transfer of a configuration to the module it must be integrated in a CAN network with a bit rate of 500 kbit/s.

3.2.4 Applicable MicroMod Services

The motherboard's inputs and outputs are controlled by the services of the MicroMod. The following table shows the assignment of the motherboard functions to the MicroMod services.

Function on motherboard	Port name	Access with MicroMod service(s)
Digital input	DIn 0 ... DIn 5	 Digital Input  Digital Function  Rotary Encoder
Frequency input (parallel to channels DI 0 to DI 3)		 Frequency Input
Temperature measurement (input values are anti-proportional to the temperature)	NTC 0, NTC 1	 Analog Input  Curve
Analog input		 Analog Input  Curve  Analog Hysteresis
Frequency output (for higher-frequency status changes)	FOut 0, FOut 2	 PWM and Frequency Output
LED DOut 7	DOut 7	 Digital Output

3.3 Status LEDs

The motherboard including the MicroMod has three LEDs with the following status indications:

LED	Indication
Power (green)	Power is applied.
DOut 7 (red)	Is linked to the digital output DO 7 of the MicroMod and can be configured freely.
Activity (red)	Status of the PCAN-MicroMod:
blinking at 1 Hz	normal operation
blinking at 2 Hz	invalid or no configuration
blinking at 5 Hz	configuration mode
continuously on	internal MicroMod error

3.4 Several MicroMods on the CAN Bus

If you want to use several MicroMods on the same CAN bus and want to configure them, each one needs its own module number. That way the MicroMods are distinguishable for the program PCAN-MicroMod Configuration.

The module number is set on the MicroMod by solder jumpers and lies in the range of 0 to 31. At **delivery** each MicroMod has the **module number 0**.

During normal operation of the PCAN-MicroMod, the module number has no effect on the CAN communication.

For setting the solder jumpers on the MicroMod unscrew the top of the casing and remove the MicroMod from the motherboard. Please find further information about the assignment of module numbers in the separate manual for the PCAN-MicroMod.



Attention! Electrostatic discharge (ESD) can damage or destroy components on the motherboard or the PCAN-MicroMod. Take precautions to avoid ESD when handling the boards.

Remounting the MicroMod

When you remount the MicroMod, take notice of the white triangular marks on each the motherboard and the MicroMod (upper left corner). These marks must align.

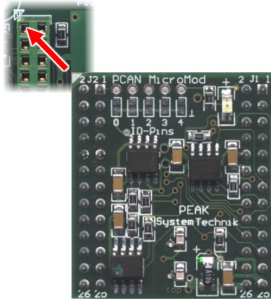

Figure 9: Positioning of the MicroMod

4 Technical specifications

Power supply

Operating voltage +U _b	8 - 26 V DC (±5 %)
Current consumption	max. 200 mA, typ. 35 mA at 12 V w/o load
Ripple 5 V	< 50 mV (U _b = 12 V, 200 mA load)
Ripple analog	< 20 mV
Reverse-polarity protection	extant; can get ineffective by the wiring with other CAN nodes (danger of destruction of electronic components)

Digital inputs

Count	6
Switching thresholds	UIH = 4 V; UIL = 3 V, contact or logic level
Input impedance	2.7 kΩ
Open input	Pull-up, optionally pull-down (in groups)
Overvoltage protection	extant
Low-pass	f _g = 7 kHz
Special feature	Frequency inputs of the PCAN-MicroMod parallel (only DI _n 0 to DI _n 3)

Digital/frequency outputs

Count	2
Maximum frequency	10 kHz (details: see user manual for the PCAN-MicroMod)
Type	Low-side
Voltage proof	< 55 V
Output current	0.75 A (constant current)
Short circuit protection	extant; short-circuit current: 1.2 A

Analog inputs	
Count	2
Measuring range	0 to 5 V, extendable
Resolution	10 bits
Sampling rate	1 kHz
Source impedance	< 5 k Ω
Overvoltage protection	extant
Low-pass	$f_g = 66$ Hz

Temperature inputs	
Count	2
Reference sensor type	Thermistor EC95F103W (e.g. RS Components part no. 151-237, form factor: bead) ¹
Measuring range	0 to 70 °C (32 to 158 °F) corresponding 5 to 0 V (antiproportional) ¹
Resolution	± 1.0 °C (due to sensor)

CAN	
Transmission standard	High-speed CAN ISO 11898-2, typ. 500 kbit/s, setup with PCAN-MicroMod Configuration (Windows software)
Termination	none
CAN ID reserved for configuration transfer	0x7E7
Module number at delivery (for configuration transfer)	0

Peculiarity Interference Immunity	
Tests	compliant to IEC 61000 and DIN EN 61326
Surge	± 500 V (specification industrial sector: ± 1 kV) ²
Line-conducted HF compatibility	10 V _{eff} (specification: 3 V _{eff})

¹ Other sensor type and measuring range on request

² This specification could only be fulfilled with ± 500 V due to the available space. Therefore, the motherboard should be used with a local power supply.

Environment

Operating temperature	-40 - +85 °C (-40 - +185 °F)
Temperature for storage and transport	-40 - +100 °C (-40 - +212 °F)
Relative humidity	15 - 90 %, not condensing
Ingress protection (IEC 60529)	IP20
EMC	DIN EN 61326-1:2013-07 EC directive 2004/108/EG

Measures

Casing size (incl. connectors)	55 x 68 x 24 mm See also dimension drawing in Appendix B on page 22
Weight	109 g

Appendix A CE Certificate

PCAN-MicroMod Mix 1/2 IPEH-002202/03 – EC Declaration of Conformity
PEAK-System Technik GmbH



Notes on the CE Symbol

The following applies to the "PCAN-MicroMod Mix 1/2" product with the item number(s) IPEH-002202/03.

EC Directive This product fulfills the requirements of EU EMC Directive 2004/108/EC (Electromagnetic Compatibility) and is designed for the following fields of application as for the CE marking:

Electromagnetic Immunity/Emission
DIN EN 61326-1, publication date 2013-07
Electrical equipment for measurement, control and laboratory use – EMC requirements – Part 1: General requirements (IEC 61326-1:2012);
German version EN 61326-1:2013

Declarations of Conformity In accordance with the above mentioned EU directives, the EC declarations of conformity and the associated documentation are held at the disposal of the competent authorities at the address below:

PEAK-System Technik GmbH
Mr. Wilhelm
Otto-Roehm-Strasse 69
64293 Darmstadt
Germany

Phone: +49 (0)6151 8173-20
Fax: +49 (0)6151 8173-29
E-mail: info@peak-system.com

A handwritten signature in black ink, appearing to read "Uwe W. St.", written over a light blue horizontal line.

Signed this 22nd day of October 2013

Appendix B Dimension Drawing

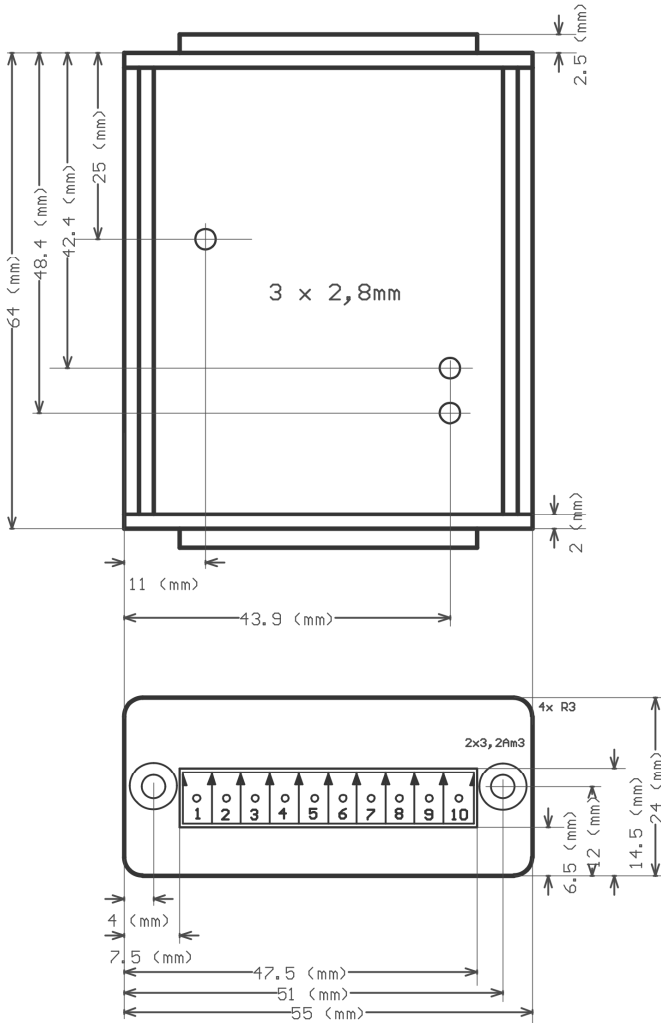

Figure 10: Top view and view of front side with connector.
The figure does not show the actual size of the product.