

PCAN-MicroMod Mix 3

Application-specific PCAN-MicroMod
Motherboard

User Manual



Document version 2.2.2 (2014-03-11)

PEAK
System

Products taken into account

Product Name	Model	Part number
PCAN-MicroMod Mix 3	Including casing and PCAN-MicroMod	IPEH-002206 from ser. no. 00200
PCAN-MicroMod Configuration	Version 2.5 (Windows software)	

CANopen® and CiA® are registered community trade marks of CAN in Automation e.V.

All other product names mentioned in this document may be the trademarks or registered trademarks of their respective companies. They are not explicitly marked by "™" and "®".

© 2014 PEAK-System Technik GmbH

PEAK-System Technik GmbH
Otto-Roehm-Strasse 69
64293 Darmstadt
Germany

Phone: +49 (0)6151 8173-20
Fax: +49 (0)6151 8173-29

www.peak-system.com
info@peak-system.com

Document version 2.2.2 (2014-03-11)

Contents

1	Introduction	4
1.1	Properties at a Glance	4
1.2	Prerequisites for Operation	6
1.3	Scope of Supply	6
2	Hardware Configuration	7
2.1	Pull-up/Pull-down Circuits for the Digital Inputs	8
2.2	High-side/Low-side Switches at Digital Outputs	9
2.3	Measuring Range Extension for the Analog Inputs	11
3	Operation	12
3.1	Pin Assignment/Applicable MicroMod Services	12
3.2	Configuration Program	14
3.2.1	System Requirements	15
3.2.2	Installing the Program	15
3.2.3	Creating a Configuration	15
3.3	Status LEDs	17
3.4	Several MicroMods on the CAN Bus	17
4	Technical Specifications	19
	Appendix A CE Certificate	22
	Appendix B Dimension Drawing	23

1 Introduction

The motherboards for PCAN-MicroMod provide an application-oriented environment. Typical characteristics of this product group include a wide supply voltage range and the protective circuit for the inputs and outputs. CANopen® firmware is available for all PCAN-MicroMod motherboards.

The Mix 3 motherboard allows the use of all inputs and outputs available on the PCAN-MicroMod.



Note: This manual only refers to the motherboard as base for a PCAN-MicroMod and to the standard firmware. For the PCAN-MicroMod and the configuration program PCAN-MicroMod Configuration, there is separate documentation.

1.1 Properties at a Glance

- Completely configurable using the Windows program PCAN-MicroMod Configuration
- Communication through High-speed CAN (ISO 11898-2)
- Operating voltage 12 V nominal, 8 to 26 V possible
- Plastic casing with Tyco automotive connectors
- Extended operating temperature range from -40 to +85 °C (-40 to +185 °F)

- └ 8 digital inputs:
 - Pull-up or pull-down circuit per input set with DIP switch
 - Schmitt trigger behavior ($V_h = 4.6\text{ V}$, $V_l = 2.0\text{ V}$), inverting
 - Low-pass behavior
 - High state at 5 to 18 V input voltage
- └ 4 frequency inputs:
 - 0 to 10 kHz
 - Pull-up or pull-down circuit per input set with DIP switch
 - Schmitt trigger behavior ($V_h = 4.6\text{ V}$, $V_l = 2.0\text{ V}$), inverting
- └ 8 analog inputs:
 - Measuring range unipolar 0 to 4.1 V
 - Resolution 10 bits
 - Sampling rate 1 kHz
 - Measuring range extension possible with voltage divider
 - Low-pass behavior
 - Protection against undervoltage and overvoltage
- └ 8 digital outputs:
 - High-side switch, 350 mA constant current, 500 mA short-circuit current
 - 4 outputs also usable as low-side switches, 700 mA constant current, 1 A short-circuit current
 - Short circuit protection

- └ 4 frequency/PWM outputs¹:
 - Low-side switch, 350 mA constant current, 1 A short-circuit current
 - 2 outputs also usable as high-side switches, 1.5 A constant current, 5 A short-circuit current
 - Short circuit protection

1.2 Prerequisites for Operation

- └ Power supply in the range of 8 to 26 V DC
- └ For creating and transferring configurations: computer with Windows 8, 7, Vista, XP (32-bit or 64-bit) and a CAN interface from the PCAN series

1.3 Scope of Supply

- └ PCAN-MicroMod
- └ PCAN-MicroMod motherboard in casing including mating connectors and crimp contacts
- └ PCAN-MicroMod Configuration for Windows
- └ Manual in PDF format

¹ Can be used as 4 PWM outputs 8-bit or 2 PWM outputs 16-bit or 2 frequency outputs.

2 Hardware Configuration

You can customize the motherboard by modifying the hardware. The following subsections contain descriptions about possible modifications.

Accessing the Motherboard

In order to carry out the modifications described in the following sections, unscrew the lid of the casing and pull off the MicroMod from the motherboard.



Attention! Electrostatic discharge (ESD) can damage or destroy components on the motherboard or the PCAN-MicroMod. Take precautions to avoid ESD when handling the boards.

Remounting the MicroMod

When you remount the MicroMod, take notice of the white triangular marks on each the motherboard and the MicroMod (upper left corner). These marks must align.

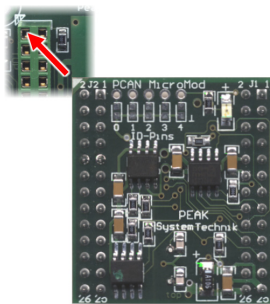

Figure 1: Positioning of the MicroMod

2.1 Pull-up/Pull-down Circuits for the Digital Inputs

At delivery the digital inputs and the frequency inputs are open. You can set them independently to pull-up or pull-down circuit. This is done with the DIP switch row S2 for the digital inputs and the row S1 for the frequency inputs.

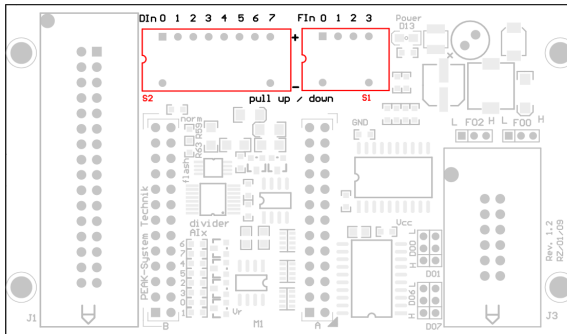

Figure 2: Positions of the pull-up/pull-down switches S2 (left) and S1 (right)

Switches	Inputs	Behavior at position		
		o (centered)*	- (down)	+ (up)
S2 1 - 8	Din 0 - Din 7	open	pull-down 4.7 kΩ	pull-up 4.7 kΩ
S1 1 - 4	Fin 0 - Fin 3			

* Setting at delivery

2.2 High-side/Low-side Switches at Digital Outputs

At delivery the digital outputs are configured as high-side switches and the frequency/PWM outputs as low-side switches. You can change the output behavior of four digital and two frequency/PWM outputs independently. This is done with jumpers which are marked with the mnemonics of the outputs.

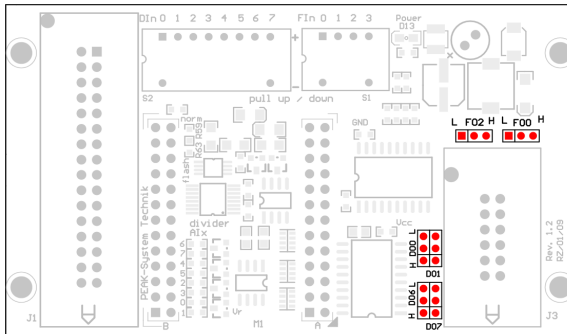



Figure 3: Positions of the jumpers for the behavior of the digital outputs

Outputs	Output behavior at jumper setting	
	H	L
Dout 0, Dout 1, Dout 6, Dout 7	High-side switch* 350 mA constant current 500 mA short-circuit current	Low-side switch 700 mA constant current 1 A short-circuit current
Fout 0, Fout 2	High-side switch 1.5 A constant current 5 A short-circuit current	Low-side switch* 350 mA constant current 1 A short-circuit current

* Setting at delivery

The high-side switches require a **separate voltage supply** via pin 1 and/or pin 2 on connector J1 (see also 3.1 *Pin Assignment/Applicable MicroMod Services* on page 12). This voltage supply is also needed for the low-side operation of the

digital outputs in order to avoid malfunctions (e.g. when using reactive loads).

 **Important note:** When you use a digital or a frequency/PWM output as **high-side switch**, the connected load must be linked to ground (**GND**). Otherwise, the overvoltage protection is not effective.

2.3 Measuring Range Extension for the Analog Inputs

At delivery the analog inputs have a unipolar measuring range from 0 to 4.1 Volts. You can extend the measuring range of an analog input with a voltage divider by soldering in a resistor (package 0603) at the respectively marked position.

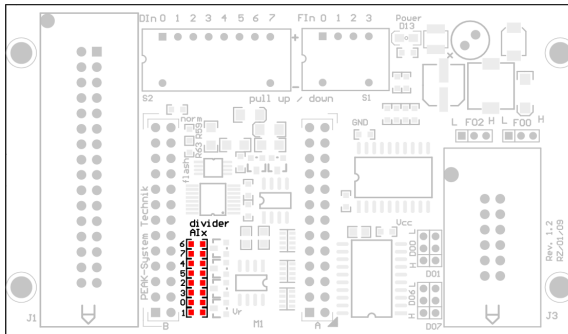

Figure 4: Resistor positions for the range extension

The resistor value R_x to be used results from the desired maximum voltage U_{\max} :

$$R_x = \frac{2400\ \Omega}{\frac{U_{\max}}{4.1V} - 1} \quad (U_{\max} > 4.1V)$$

Example values:

U_{\max}	R_x (rounded)
5 V	11 k Ω
10 V	1.7 k Ω

Resistor position	Analog input Ain x
6	Ain 6
7	Ain 7
4	Ain 4
5	Ain 5
2	Ain 2
3	Ain 3
0	Ain 0
1	Ain 1

3 Operation

3.1 Pin Assignment/Applicable MicroMod Services







The motherboard has a 32-pin and a 12-pin connector. For each connector on the motherboard a mating connector is delivered which you can allocate as needed. For this use the delivered crimp contacts.



V _{Bat} (8-24V)	17	1	V _{HSout} (8-33V)		
Din 0	18	2	V _{HSout} (8-33V)		
Din 2	19	3	Din 1		
Din 4	20	4	Din 3		
Din 6	21	5	Din 5		
Fin 0	22	6	Din 7		
Fin 2	23	7	Fin 1		
GND	24	8	Fin 3		
V24-TxD	25	9	V24-RxD		
CAN-H	26	10	CAN-L		
Aout 0	27	11	Aout 1	Fout 3	12 6 Fout 2
AGND	28	12	GND	Fout 1	11 5 Fout 0
Ain 7	29	13	Ain 6	Dout 0	10 4 Dout 1
Ain 5	30	14	Ain 4	Dout 2	9 3 Dout 3
Ain 3	31	15	Ain 2	Dout 4	8 2 Dout 5
Ain 1	32	16	Ain 0	Dout 6	7 1 Dout 7

Figure 5: Pin assignment of the Mix 3 motherboard

The following table shows the pin assignment and the assignment of the motherboard functions to the MicroMod services. The motherboard's inputs and outputs are controlled by the services of the MicroMod.

Pin J1	Port name	Function	Access with MicroMod service(s)
17	V _{Bat}	Voltage supply motherboard, 8 - 26 V DC	
1 2	V _{HSout}	Voltage supply high-side driver of the digital outputs (also needed for the low-side operation), 8 - 33 V DC	

Pin J1	Port name	Function	Access with MicroMod service(s)
18	Din 0	Digital input High state at 5 to 18 V input voltage Schmitt trigger behavior, inverting Low-pass behavior Pull-up/pull-down (4.7 k Ω) with DIP switches S2, setting at delivery: open	 Digital Input  Digital Function  Rotary Encoder
3	Din 1		
19	Din 2		
4	Din 3		
20	Din 4		
5	Din 5		
21	Din 6		
6	Din 7		
22	Fin 0	Frequency input 0 - 10 kHz Schmitt trigger behavior Pull-up/pull-down (4.7 k Ω) with DIP switches S1, setting at delivery: open	 Frequency Input
7	Fin 1		
23	Fin 2		
8	Fin 3		
24	GND	Digital ground	
25	V24-TxD	(Reserved)	
9	V24-RxD		
26	CAN-H	Differential CAN signal (High-speed CAN, ISO 11898-2)	
10	CAN-L		
27	Aout 0	(Reserved)	
11	Aout 1		
28	AGND	Analog ground	
12	GND	Digital ground	
29	Ain 7	Analog input Pull-down circuit Measuring range unipolar, 0 to 4.1 V Measuring range extension possible with voltage divider Low-pass behavior Protection against undervoltage and overvoltage	 Analog Input  Curve  Analog Hysteresis
13	Ain 6		
30	Ain 5		
14	Ain 4		
31	Ain 3		
15	Ain 2		
32	Ain 1		
16	Ain 0		

Pin J3	Port name	Function	Access with MicroMod service(s)	
12	Fout 3	Frequency/PWM outputs Low-side switch 350 mA constant current 1 A short-circuit current	 PWM and Frequency Output	
6	Fout 2			High-side switch by jumper 1.5 A constant current 5 A short-circuit current
11	Fout 1			
5	Fout 0			(See Fout 2)
10	Dout 0	Digital output High-side switch 350 mA constant current 500 mA short-circuit current	 Digital Output	
4	Dout 1			High-side switch by jumper 700 mA constant current 1 A short-circuit current
9	Dout 2			
3	Dout 3			
8	Dout 4			
2	Dout 5			
7	Dout 6			
1	Dout 7	(See Dout 0/1)		

 **Important note:** When you use a digital or a frequency/PWM output as **high-side switch**, the connected load must be linked to ground (**GND**). Otherwise, the overvoltage protection is not effective.

3.2 Configuration Program

In order to create and transfer MicroMod configurations the Windows software PCAN-MicroMod Configuration is used. This section covers basic points about installation and use of the program with the Mix 3 motherboard.

You'll find detailed information about the use of PCAN-MicroMod Configuration in the related documentation which is invoked via the program (e.g. with **F1**).

3.2.1 System Requirements

- └ Windows 8, 7, Vista, XP (32-bit or 64-bit)
- └ Computer with CAN interface of the PCAN series (for transferring a configuration to the PCAN-MicroMod via CAN)

3.2.2 Installing the Program

Under Windows install the program from the supplied CD. Start the corresponding installation routine by using the CD navigation going to **Tools > PCAN-MicroMod Configuration 2.5.x**.

3.2.3 Creating a Configuration

When you start creating a new configuration in PCAN-MicroMod Configuration, the **Board Type** dialog box appears in order to select the type of the used motherboard. The necessary settings are explained in the following.

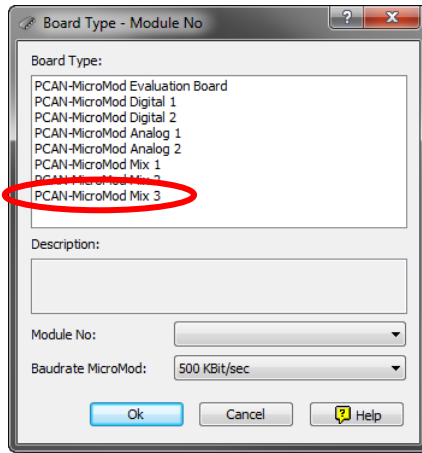

Figure 6: PCAN-MicroMod Configuration: selection of the Mix 3 motherboard

Board Type: PCAN-MicroMod Mix 3

Module No: 0

The module number of the MicroMod on the Mix 3 motherboard is set to 0 at delivery and is relevant if you want to configure more than one MicroMod on the same CAN bus. See also section 3.4 *Several MicroMods on the CAN Bus* on page 17.

Bitrate MicroMod: 500 kbit/s

At delivery the MicroMod is set to a bit rate of 500 kbit/s. A change of this setting will take effect after sending the completed configuration to the MicroMod.



Note: For the first transfer of a configuration to the module it must be integrated in a CAN network with a bit rate of 500 kbit/s.

3.3 Status LEDs

The motherboard including the MicroMod has two LEDs with the following status indications:

LED	Indication
Power (green)	Power is applied.
Activity (red)	Status of the PCAN-MicroMod:
blinking at 1 Hz	normal operation
blinking at 2 Hz	invalid or no configuration
blinking at 5 Hz	configuration mode
continuously on	internal MicroMod error

3.4 Several MicroMods on the CAN Bus

If you want to use several MicroMods on the same CAN bus and want to configure them, each one needs its own module number. That way the MicroMods are distinguishable for the program PCAN-MicroMod Configuration.

The module number is set on the MicroMod by solder jumpers and lies in the range of 0 to 31. At **delivery** each MicroMod has the **module number 0**.

During normal operation of the PCAN-MicroMod, the module number has no effect on the CAN communication.

For setting the solder jumpers on the MicroMod unscrew the top of the casing and remove the MicroMod from the motherboard. Please find further information about the assignment of module numbers in the separate user manual for the PCAN-MicroMod.



Attention! Electrostatic discharge (ESD) can damage or destroy components on the motherboard or the PCAN-MicroMod. Take precautions to avoid ESD when handling the boards.

Remounting the MicroMod

When you remount the MicroMod, take notice of the white triangular marks on each the motherboard and the MicroMod (upper left corner). These marks must align.

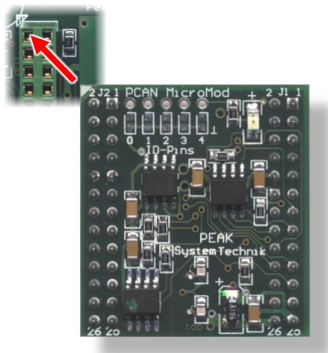

Figure 7: Positioning of the MicroMod

4 Technical specifications

Power supply	
Voltage supply V_{Bat} motherboard	12 V DC nom., 8 - 26 V possible
Voltage supply V_{HSout} high-side drivers	12 V DC nom., 8 - 33 V possible
Current consumption	60 mA at 12 V on V_{Bat} (all outputs passive)
Digital inputs	
Count	8
Input voltage Low	$\leq 2.0 \text{ V}$
Input voltage High	$\geq 4.6 \text{ V}$
Maximum input voltage	18 V
Circuit	open (130 k Ω , weak pull-down), pull-up (4.7 k Ω), pull-down (4.7 k Ω)
Further properties	Schmitt trigger behavior, inverting
Frequency inputs	
Count	4
Frequency range	0 - 10 kHz
Input voltage Low	$\leq 2.0 \text{ V}$
Input voltage High	$\geq 4.6 \text{ V}$
Maximum input voltage	18 V
Circuit	open (130 k Ω , weak pull-down), pull-up (4.7 k Ω), pull-down (4.7 k Ω)
Further properties	Schmitt trigger behavior

Analog inputs

Count	8
Measuring range	0 - 4.1 V, unipolar, extensible through voltage divider with resistors
Resolution	10 bits
Sampling rate	1 kHz
Input impedance	100 k Ω (at measuring range 4.1 V)
Source impedance	< 5 k Ω
Low-pass	$\tau = 2.5$ ms
Further properties	Pull-down circuit Protection against undervoltage and overvoltage

Digital outputs

Count	8	
Circuit	High-side switch 4 outputs alternatively configurable as low-side switch Short circuit protection	
	High-side:	Low-side:
Constant current	max. 350 mA	max. 700 mA
Short-circuit current	500 mA	1 A

Frequency/PWM outputs

Count	4, can be used as - 4 PWM outputs 8-bit or - 2 PWM outputs 16-bit or - 2 frequency outputs	
Maximum frequency	10 kHz (details: see user manual for the PCAN-MicroMod)	
Circuit	Low-side switch 2 outputs alternatively configurable as high-side switch Short circuit protection	
	Low-side:	High-side:
Constant current	max. 350 mA	max. 1.5 A
Short-circuit current	1 A	5 A

CAN

Transmission standard	High-speed CAN ISO 11898-2, typ. 500 kbit/s, setup with PCAN-MicroMod Configuration (Windows software)
Termination	none
CAN ID reserved for configuration transfer	0x7E7
Module number at delivery (for configuration transfer)	0

Measures

Casing size	100 x 60 x 27 mm See also dimension drawing in Appendix B on page 23
Weight	100 g (without connectors)

Environment

Operating temperature	-40 - +85 °C (-40 - +185 °F)
Temperature for storage and transport	-40 - +100 °C (-40 - +212 °F)
Relative humidity	15 - 90 %, not condensing
Ingress protection (IEC 60529)	IP20
EMC	DIN EN 61326-1:2013-07 EC directive 2004/108/EG

Appendix A CE Certificate

PCAN-MicroMod Mix 3 IPEH-002206 – EC Declaration of Conformity
PEAK-System Technik GmbH



Notes on the CE Symbol

The following applies to the "PCAN-MicroMod Mix 3" product with the item number(s) IPEH-002206 (from serial number 00200).

EC Directive This product fulfills the requirements of EU EMC Directive 2004/108/EC (Electromagnetic Compatibility) and is designed for the following fields of application as for the CE marking:

Electromagnetic Immunity/Emission

DIN EN 61326-1, publication date 2013-07

Electrical equipment for measurement, control and laboratory use – EMC requirements – Part 1: General requirements (IEC 61326-1:2012);
German version EN 61326-1:2013

Declarations of Conformity In accordance with the above mentioned EU directives, the EC declarations of conformity and the associated documentation are held at the disposal of the competent authorities at the address below:

PEAK-System Technik GmbH

Mr. Wilhelm
Otto-Roehm-Strasse 69
64293 Darmstadt
Germany

Phone: +49 (0)6151 8173-20
Fax: +49 (0)6151 8173-29
E-mail: info@peak-system.com

A handwritten signature in black ink, appearing to read "Uwe W. ...".

Signed this 22nd day of October 2013

Appendix B Dimension Drawing

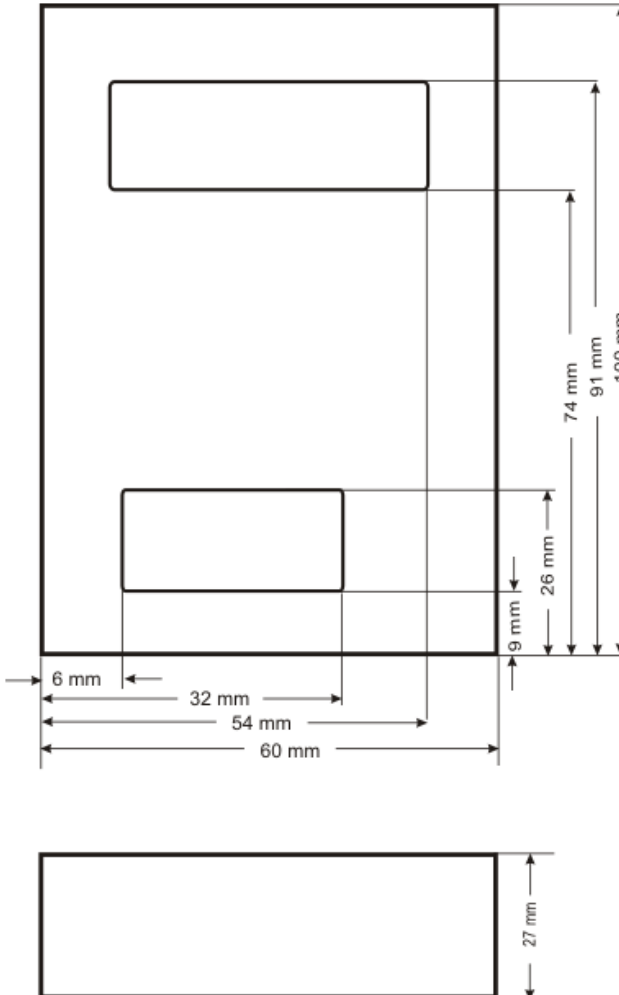

Figure 8: View of casing.
The figure does not show the actual size of the product.